

VEGA S - RGB

Mid Power LED 24 Vdc - Pitch 8,3 mm

ALDABRA
LUCE CONTEMPORANEA

Submittal

Project: _____ Date: _____
 Product Type: _____ Product Code: _____
 Ordering Info: _____



Product Description

Illuminated handrail made of anodized aluminum extrusion and nanopolymer resin that ensures a complete waterproofing. Designed for indoor and outdoor environments, the homogeneous, downward-oriented illumination comes from the underside of the product. It can be mounted directly to walls or on proper steel bollards.



Light Source

Light Source	Mid Power LED LM 80 COMPLIANT
Colour Temperature (CCT) !	RGB
Pitch	8,3 mm (0.326")
Cutting Pitch	50 mm (1.97")
Power	10 W/m (3 W/ft)
Colour Rendering Index	> 90
Chromatic Selection	Mac Adam 3-Step
Light Source Efficiency	lm/W
Fixture Luminous Flux	lm/m (lm/ft)
LED Type	_____

Technical Drawing

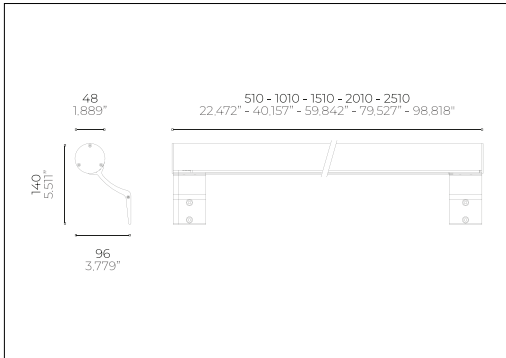

Power Supply

Voltage	24 Vdc Constant Voltage
Dimming	PWM
Control Systems Compatibility	DALI; DMX
Driver	Remote

Fixture

Materials	Aluminium Anticorodal EN AW-6060; Resin
Body Finishes !	Anodized Aluminium
Weight	2900 g/m (1.95 lb/ft)
Power Supply Cable	1m (3,28ft) - 2xAWG18 (Red;Black) + 3xAWG20 (R/b; G/b; B/b)
Optics !	_____
Diffusers	Transparent
Screens	_____

Installations

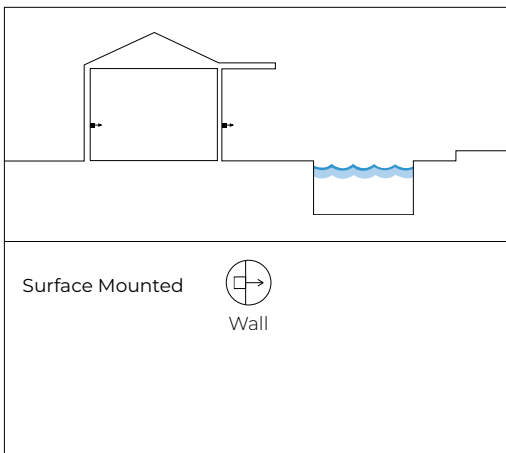

Temperature and Durability

LED Lifetime T_a 25°C	> 50000 h (TM21 L80 B10 @50000 h)
Fixture Lifetime	> 50000 h
T_a Performance	25°C (77°F)
T_a Operative	-30 ÷ 50 °C (-22 ÷ 122 °F)
Body Temperature	< 90 °C (194 °F)
Surface Temperature	≤ 65 °C (149 °F)

Installation

Electrical Insulation Class	III
IP Protection Degrees	IP66
Impact Resistance	IK08
Driveability	_____
Walkability	_____
Certifications	CE
Normative	EN60598-1 ; EN60598-2 and its parts

! Note: contact the factory for custom CCT, optics, finishes and lengths



750°C

AQA STOP FLEX

A A+ A++

Note:

- Power supplies, control&dimming devices and fixing kits must to be orderd separately. - Aldabra power supply consumption is equal to 15% of the fixture nominal power. - Specifications are subject to change without notice. - Photometric data available at www.aldabra.it - Aldabra, all rights reserved.

VEGA S - RGB

Mid Power LED 24 Vdc - Pitch 8,3 mm

ALDABRA
LUCI CONTEMPORANEA

Part Number

example: **VEG.21.T90A1.0**



Length & Power¹

- VEG.20** 510 mm / 1.67 ft - 5 W
- VEG.21** 1010 mm / 3.31 ft - 10 W
- VEG.22** 1510 mm / 4.95 ft - 15 W
- VEG.23** 2010 mm / 6.59 ft - 20 W
- VEG.24** 2510 mm / 8.235 ft - 25 W

Optical Features¹

- .T** Transparent Diffuser

CCT¹

- 90** RGB

Finishes¹

- A1.0** Anodized Aluminium

Notes:

Surface Mounted Installation Accessories

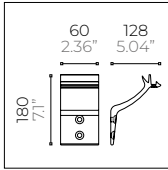

- ACC.0382.0**
Wall Bracket for Vega S Wall Bracket

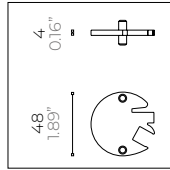

- ACC.0383.0**
Connection Kit for Vega S

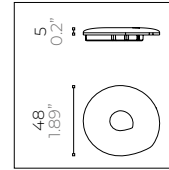

- ACC.0384.0**
End Caps Kit for Vega S

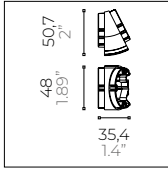

- ACC.0398.0**
Upward Stair Ramp Connection for Vega S (closed corner 150°)

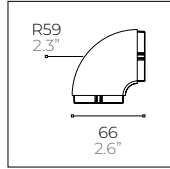

- ACC.0386.0**
90° Bend Right for Vega S

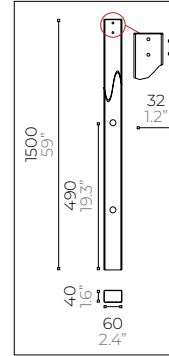

- ACC.0385.0**
Stainless Steel Pole for Vega S

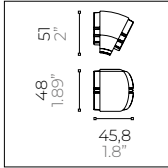

- ACC.0399.0**
Downward Stair Ramp Connection for Vega S (closed corner 210°)

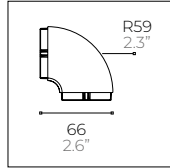

- ACC.0400.0**
90° Bend Left for Vega S

Generic Accessories



- ACC.0005.0**
IP68 Waterproof connection box with gel
4 channels - 3 poles

General Informations:

Kindly note that atmospheric agents (such as lightnings, etc), electrostatics charges or disturbances on the installation not caused by Aldabra lighting fixtures and Led drivers indicated by Aldabra itself, may cause damages on the fixtures. It is necessary that the electrical installation where the LED lighting fittings and their power supply units and control gears are installed must be equipped with proper devices for the protection and suppression of transient phenomena (SPD, isolation transformer, etc...). Such devices must be coordinated with the other protections of the installation; on this theme, it's necessary to refer to the electrical installations norms which are in force in each country.