

# STRATO - RGB MOVE Pixel to Pixel

Mid Power LED 24 Vdc - Pitch 16,7 mm

**ALDABRA**  
LUCE CONTEMPORANEA

## Submittal

Project: \_\_\_\_\_ Date: \_\_\_\_\_  
 Product Type: \_\_\_\_\_ Product Code: \_\_\_\_\_  
 Ordering Info: \_\_\_\_\_



## Product Description

High-efficiency professional modular linear system for recessed floor or wall installation using formwork, or surface installation with adjustable brackets for direct or indirect lighting, suitable for outdoor or indoor environments. Made of extruded aluminum alloy UNI 6060 with a natural anodized finish, and screen made of PMMA.

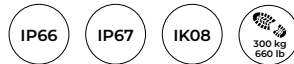

## Light Source

Light Source	Mid Power LED LM 80 COMPLIANT
Colour Temperature (CCT) !	RGB MOVE - Pixel to Pixel
Pitch	16,7 mm (0.657")
Cutting Pitch	100 mm (3.93")
Power	14,4 W/m (4.4 W/ft)
Colour Rendering Index	> 90
Chromatic Selection	Mac Adam 3-Step
Light Source Efficiency	lm/W
Fixture Luminous Flux	lm/m (lm/ft)
LED Type	_____

## Technical Drawing

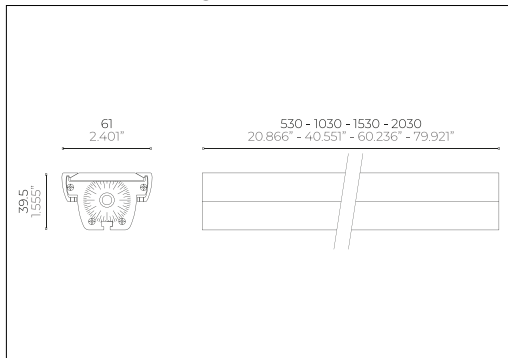

## Power Supply

Voltage	24 Vdc Constant Voltage
Dimming	PWM
Control Systems Compatibility	DALI; DMX
Driver	Remote

## Fixture

Materials	Aluminium Anticorodal EN AW-6060; PMMA
Body Finishes !	Anodized Aluminium
Weight	2000 g/m (1.344 lb/ft)
Power Supply Cable	1m (3,28ft) - 2xAWG18 (Red;Black) + 3xAWG20 (R/b, G/b, B/b)
Optics !	_____
Diffusers	Opal; Transparent
Screens	_____

## Installations

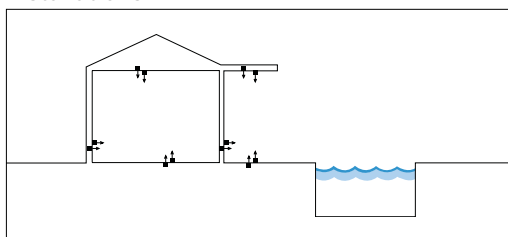

Recessed			
	Wall	Ceiling	Ground
Surface Mounted			
	Wall	Ceiling	Ground

## Temperature and Durability

LED Lifetime T <sub>8</sub> 25°C	> 50000 h (TM21 L80 B10 @50000 h)
Fixture Lifetime	> 50000 h
T <sub>8</sub> Performance	25°C (77°F)
T <sub>8</sub> Operative	-30 ÷ 50 °C (-22 ÷ 122 °F)
Body Temperature	< 90 °C (194 °F)
Surface Temperature	≤ 65 °C (149 °F)

## Installation

Electrical Insulation Class	III
IP Protection Degrees	IP66; IP67
Impact Resistance	IK08
Driveability	_____
Walkability	300 kg (660 lb)
Certifications	CE; UL listed
Normative	EN60598-1; EN60598-2 and its parts; UL 676; CSA C222 No. 89-15; UL 2108; UL 1598/C250-08

! Note: contact the factory for custom CCT, optics, finishes and lengths



650°C

AQA STOP FLEX

A A+ A++

## Note:

- Power supplies, control&dimming devices and fixing kits must to be orderd separately. - Aldabra power supply consumption is equal to 15% of the fixture nominal power. - Specifications are subject to change without notice. - Photometric data available at [www.aldabra.it](http://www.aldabra.it) - Aldabra, all rights reserved.

# STRATO - RGB MOVE Pixel to Pixel

Mid Power LED 24 Vdc - Pitch 16,7 mm

**ALDABRA**  
LUCE CONTEMPORANEA

## Part Number

example: STR.21.T92A1.0



### Length & Power <sup>1</sup>

- STR.21** 530 mm / 1.738 ft - 7,2 W
- STR.22** 1030 mm / 3.379 ft - 14,4 W
- STR.23** 1530 mm / 5.019 ft - 21,6 W
- STR.24** 2030 mm / 6.66 ft - 28,8 W

### Optical Features <sup>1</sup>

- .D** Opal Diffuser
- .T** Transparent Diffuser

### CCT <sup>1</sup>

- 92** RGB MOVE

### Finishes <sup>1</sup>

- A1.0** Anodized Aluminium

Notes: \_\_\_\_\_

## Recessing Box

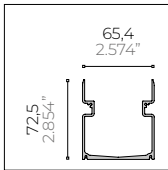

### Type A Anodized Aluminium Trimless Recessing Box

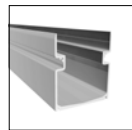

- CSF.0061.0** 550 mm / 1.804 ft
- CSF.0062.0** 1050 mm / 3.444 ft
- CSF.0063.0** 1550 mm / 5.085 ft
- CSF.0064.0** 2050 mm / 6.725 ft

## Recessed Installation Accessories



- ACC.0003.0**  
Alignment kit for recessing box

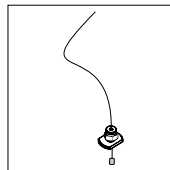

- ACC.0028.0**  
Safety steel wire for ceiling installation for preventing accidental fall



- ACC.0066.0**  
Fixing kit in recessing box



- ACC.0080.0**  
Couple of end caps for Strato recessing box type A

## Surface Mounted Installation Accessories

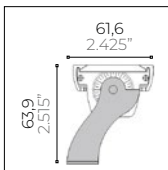

- ACC.0065.0**  
Couple of adjustable brackets

## Generic Accessories



- ACC.0005.0**  
IP68 Waterproof connection box with gel  
4 channels - 3 poles

## General Informations:

Kindly note that atmospheric agents (such as lightnings, etc), electrostatics charges or disturbances on the installation not caused by Aldabra lighting fixtures and Led drivers indicated by Aldabra itself, may cause damages on the fixtures. It is necessary that the electrical installation where the LED lighting fittings and their power supply units and control gears are installed must be equipped with proper devices for the protection and suppression of transient phenomena (SPD, isolation transformer, etc...). Such devices must be coordinated with the other protections of the installation; on this theme, it's necessary to refer to the electrical installations norms which are in force in each country.