

STRATO - Monochromatic

Power LED 24 Vdc - Pitch 50 mm - Bus on Board

ALDABRA
LUCE CONTEMPORANEA

Submittal

Project: _____ Date: _____
 Product Type: _____ Product Code: _____
 Ordering Info: _____



Product Description

High-efficiency professional modular linear system for recessed floor or wall installation using formwork, or surface installation with adjustable brackets for direct or indirect lighting, suitable for outdoor or indoor environments. Made of extruded aluminum alloy UNI 6060 with a natural anodized finish, and screen made of PMMA.

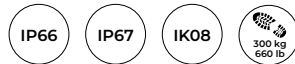

Light Source

Light Source	Power LED LM 80 COMPLIANT
Colour Temperature (CCT) †	2700K; 3000; 4000K
Pitch	50 mm (1.97")
Cutting Pitch	100; 200; 250; 350; 450 mm (3.93"; 7.87"; 9.84"; 13.78"; 17.72")
Power	44 W/m (7.32 W/ft)
Colour Rendering Index	> 90
Chromatic Selection	Mac Adam 2-Step
Light Source Efficiency	lm/W
Fixture Luminous Flux	lm/m (lm/ft)
LED Type	_____

Technical Drawing

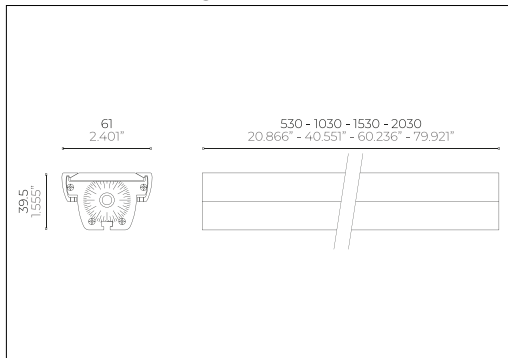

Power Supply

Voltage	24 Vdc Constant Voltage
Dimming	PWM
Dimming Systems Compatibility	0-10V; 1-10V; DALI; DMX
Driver	Remote

Fixture

Materials	Aluminium Anticorodal EN AW-6060; PMMA
Body Finishes †	Anodized Aluminium
Weight	2000 g/m (1.344 lb/ft)
Power Supply Cable	1m (3,28ft) Ø 6,2mm - 2xAWG18 (Red;Black) + 1xAWG20 (Violet)
Optics †	Narrow 9°; Medium 24°; Wide 43°; Elliptical 40° x 15°
Diffusers	Opal
Screens	Elliptical 38° x 15° + Louver

Installations

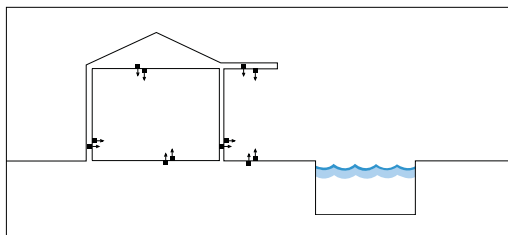

Recessed			
	Wall	Ceiling	Ground
Surface Mounted			
	Wall	Ceiling	Ground

Temperature and Durability

LED Lifetime T ₈₀ 25°C	> 50000 h (TM21 L80 B10 @50000 h)
Fixture Lifetime	> 50000 h
T ₈₀ Performance	25°C (77°F)
T ₈₀ Operative	-30 ÷ 50 °C (-22 ÷ 122 °F)
Body Temperature	< 90 °C (194 °F)
Surface Temperature	≤ 65 °C (149 °F)

Installation

Electrical Insulation Class	III
IP Protection Degrees	IP66; IP67
Impact Resistance	IK08
Driveability	_____
Walkability	300 kg (660 lb)
Certifications	CE; UL listed
Normative	EN60598-1; EN60598-2 and its parts; UL 676; CSA C222 No. 89-15; UL 2108; UL 1598/C250-08

! Note: contact the factory for custom CCT, optics, finishes and lengths



650°C

AQA STOP FLEX

A A+ A++

Note:

- Power supplies, control&dimming devices and fixing kits must be ordered separately. - Aldabra power supply consumption is equal to 15% of the fixture nominal power. - Specifications are subject to change without notice. - Photometric data available at www.aldabra.it - Aldabra, all rights reserved.

STRATO - Monochromatic

Power LED 24 Vdc - Pitch 50 mm - Bus on Board

ALDABRA
LUCE CONTEMPORANEA

Part Number

example: STR.15.T30A1.0



Length & Power ¹

- STR.13** 530 mm / 1.738 ft - 22 W
- STR.14** 1030 mm / 3.379 ft - 44 W
- STR.15** 1530 mm / 5.019 ft - 66 W
- STR.16** 2030 mm / 6.66 ft - 88 W

Optical Features ¹

- .M** Narrow Beam 9°
- .F** Medium Beam 24°
- .W** Wide Beam 43°
- .E** Elliptical Optics 40°x15°
- .U** Elliptical Optics + Louver 38°x15°
- .D** Opal Diffuser

CCT ¹

- 27** 2700K
- 30** 3000K
- 40** 4000K

Finishes ¹

- A1.0** Anodized Aluminium

Notes: _____

Recessing Box

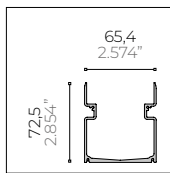

Type A Anodized Aluminium Trimless Recessing Box

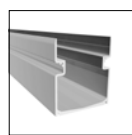

- CSF.0061.0** 550 mm / 1.804 ft
- CSF.0062.0** 1050 mm / 3.444 ft
- CSF.0063.0** 1550 mm / 5.085 ft
- CSF.0064.0** 2050 mm / 6.725 ft

Recessed Installation Accessories



- ACC.0003.0**
Alignment kit for recessing box

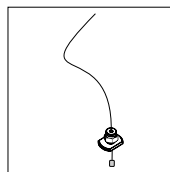

- ACC.0028.0**
Safety steel wire for ceiling installation for preventing accidental fall



- ACC.0066.0**
Fixing kit in recessing box



- ACC.0080.0**
Couple of end caps for Strato recessing box type A

Surface Mounted Installation Accessories

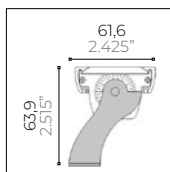

- ACC.0065.0**
Couple of adjustable brackets

Generic Accessories



- ACC.0005.0**
IP68 Waterproof connection box with gel
4 channels - 3 poles

General Informations:

Kindly note that atmospheric agents (such as lightnings, etc), electrostatics charges or disturbances on the installation not caused by Aldabra lighting fixtures and Led drivers indicated by Aldabra itself, may cause damages on the fixtures. It is necessary that the electrical installation where the LED lighting fittings and their power supply units and control gears are installed must be equipped with proper devices for the protection and suppression of transient phenomena (SPD, isolation transformer, etc...). Such devices must be coordinated with the other protections of the installation; on this theme, it's necessary to refer to the electrical installations norms which are in force in each country.